

JUNG

A new generation

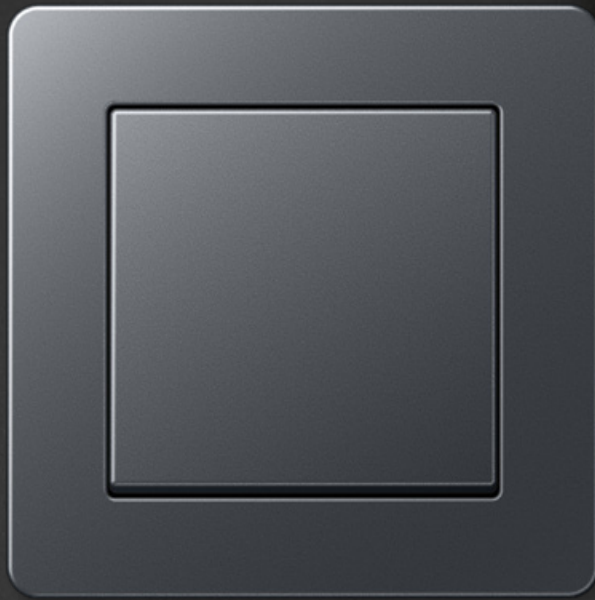

A FLOW

MADE IN GERMANY SINCE 1912

# A FLOW

Life is movement, progress and change. Everything is in flux. With its light, harmonious design, A FLOW easily accommodates all changes.

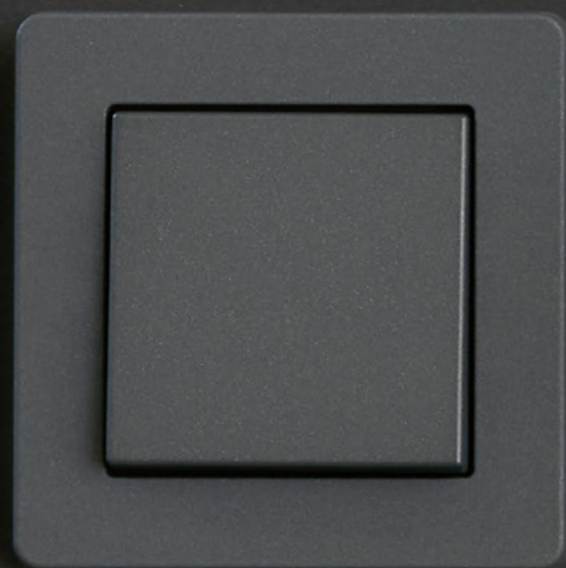





A FLOW in matt graphite black

## Stylish everywhere



The soft design of A FLOW blends confidently into a wide variety of furnishing styles. Modern and flexible — ideal for young living.



A FLOW in matt snow white

## Simply harmonious



Characteristic, slightly rounded edges and six timeless colours — A FLOW remains stylish, even if contemporary taste changes.

Form and function go hand in hand with A FLOW. The push-button sensors provide space for labelling and are available for KNX and eNet systems.

F 50 push-button sensor, 2-gang

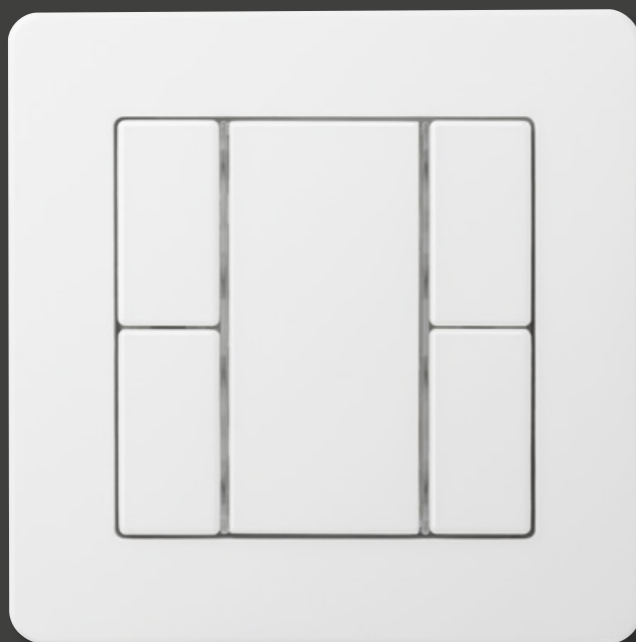

Dimmer and socket combination

## Form and function

The functional diversity of A FLOW perfectly covers all areas of modern electrical installation: from light, temperature, shutters or music to Smart Home solutions.



Standard timer with display: real glass front in black or white with six sensor buttons for intuitive operation – this makes the control of lighting and shading particularly convenient.

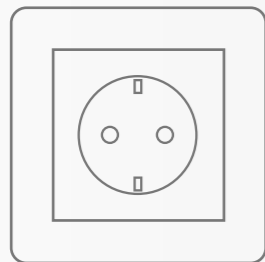

SCHUKO® Standard

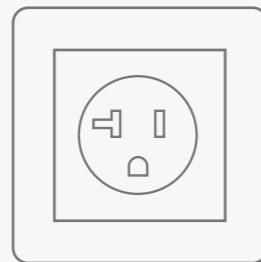

US NEMA Standard

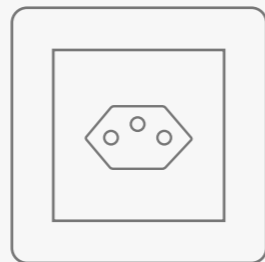

Swiss Standard, Type 13

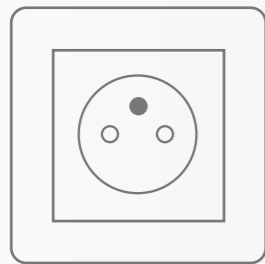
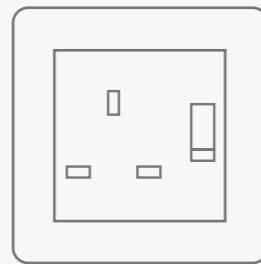
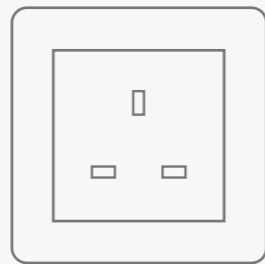
Socket with earth pin,  
French / BelgianBritish Standard 13 A,  
switchable

British Standard 13 A

## Global Player

Thanks to international socket systems, A FLOW can be connected worldwide. Special feature of the range: frame and insert are flush.



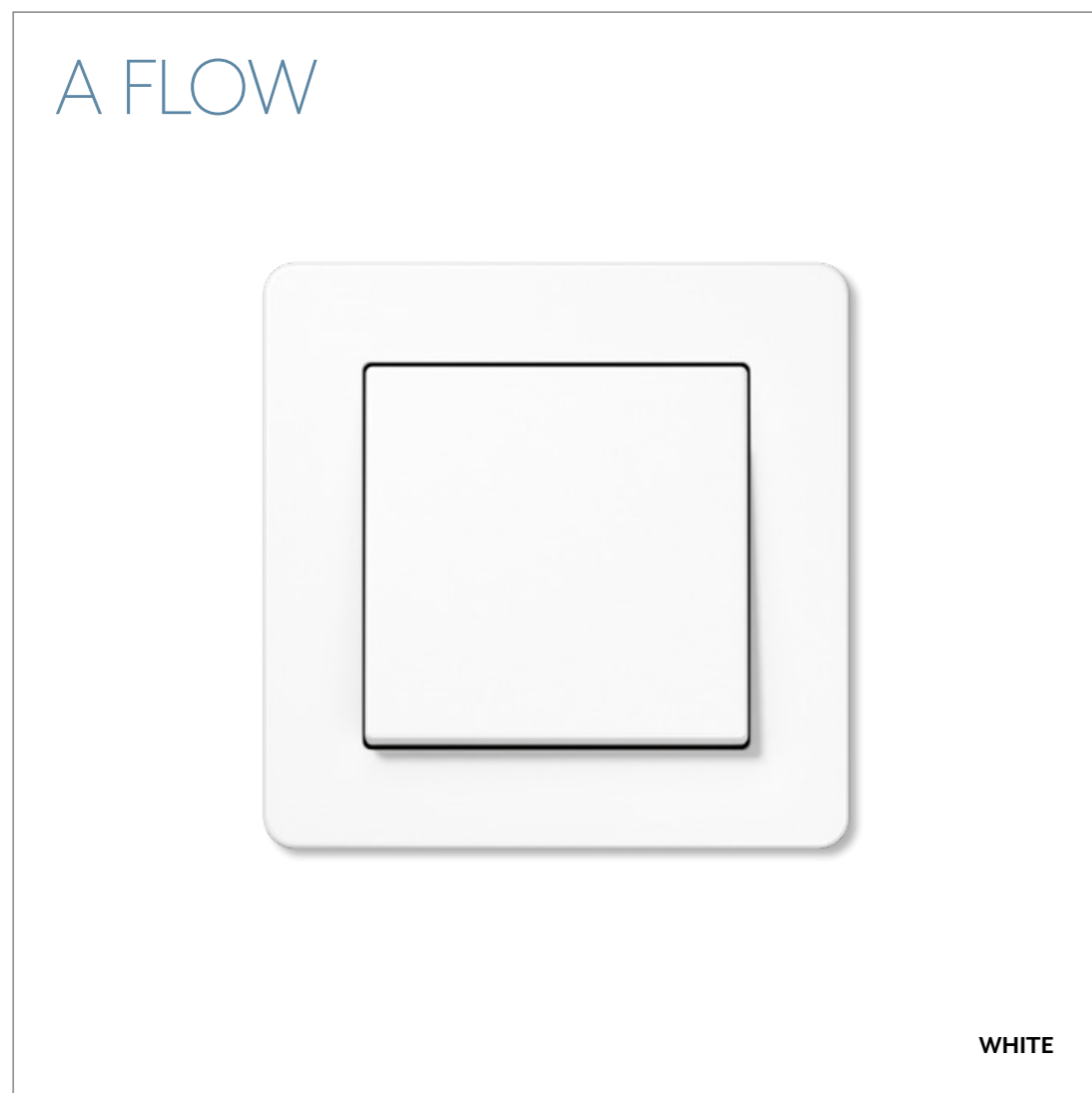

The mounting in 1- to 5-gang frames according to the JUNG modular system allows numerous possible combinations.

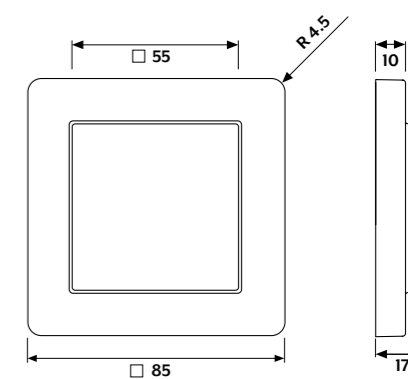
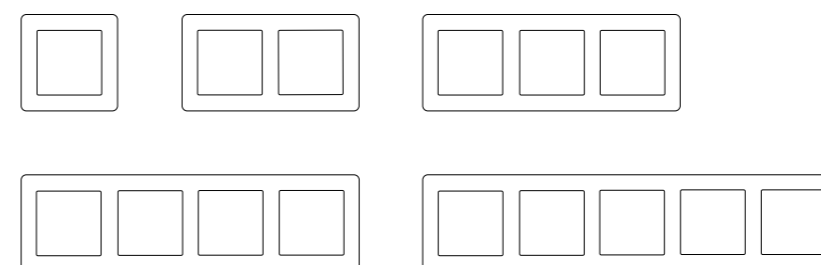
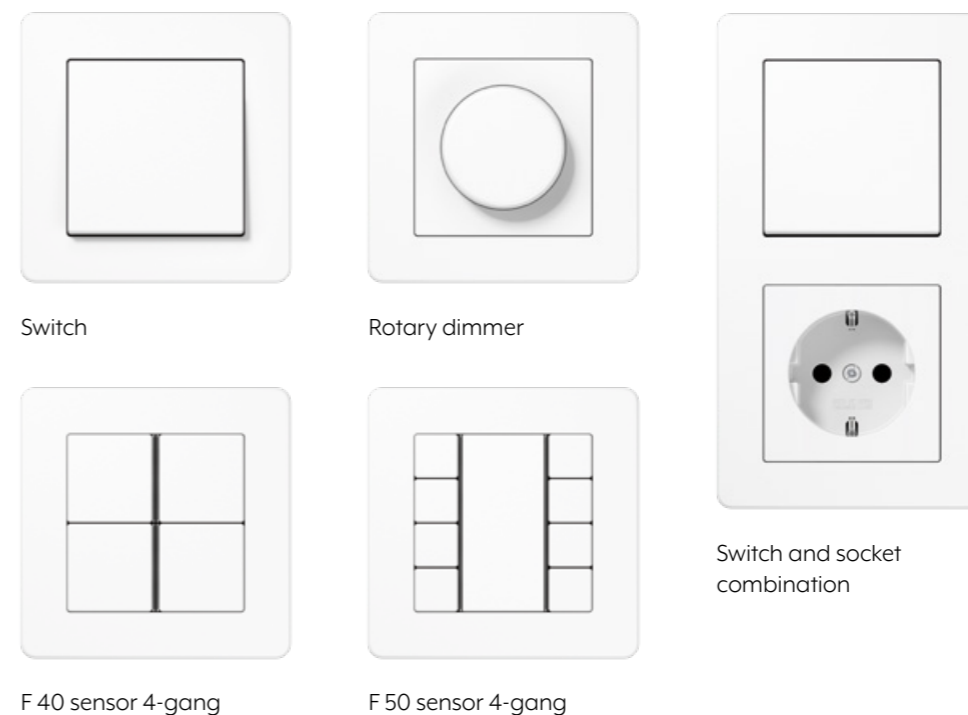

**Frame material**

Thermoplastic

Recommendation: Combine the frame with a cover made of thermoplastic (breakproof) high-gloss material.

**Coloures**

- White
- Matt snow white
- Black
- Matt graphite black
- Aluminium
- Matt anthracite

**Frame dimensions**

1-gang	85 mm x 85 mm
2-gang	85 mm x 156 mm
3-gang	85 mm x 227 mm
4-gang	85 mm x 298 mm
5-gang	85 mm x 369 mm

The frames can be installed horizontally or vertically.





Ernst Paris

Company founder Albrecht Jung

## Progress as tradition

As a pioneer of his time, Albrecht Jung created the basis for the JUNG success story with the founding of the company in 1912 and the development of his pull switch with 1/8 rotation. The original motivation remains the driving force for all products to this day: JUNG develops and produces timelessly designed products and future-oriented solutions with pioneering spirit. As a premium supplier of modern building technology, the portfolio of the traditional medium-sized company includes switches, sockets, dimmers, observers and systems for controlling functions.

Convenient regulation of lighting, temperature and shutters, music in every room, timeless switch design, intelligent security systems or the smart control of the entire technology via touchscreen — JUNG stands for a skilful interplay between design requirements and innovation.

### WE ARE JUNG:

**1912** Medium sized third generation family company



“Made in Germany” for more than 100 years



Around 1,400 employees



20 subsidiaries and over 70 agencies worldwide

## Products “Made in Germany” — manufactured with precision



JUNG products are manufactured at the two company sites in Schalksmühle and Lünen. For this, JUNG received the certificate “Made in Germany” from TÜV Nord in 2011. With deep roots in the region and a constant employer for many decades, today customers throughout the world rely on the continuing high quality. At the same time, JUNG is aware of its high responsibility for sustainable and

energy-efficient production. JUNG has proven its specialist know-how in metalworking for decades. The company provides its switch designs in genuine metal. Matt finished or lacquered aluminium, stainless steel blasted with glass beads, brushed brass, chrome-plated metal or with almost 24 carat gold plating — JUNG produces precision switches down to the last detail every day.

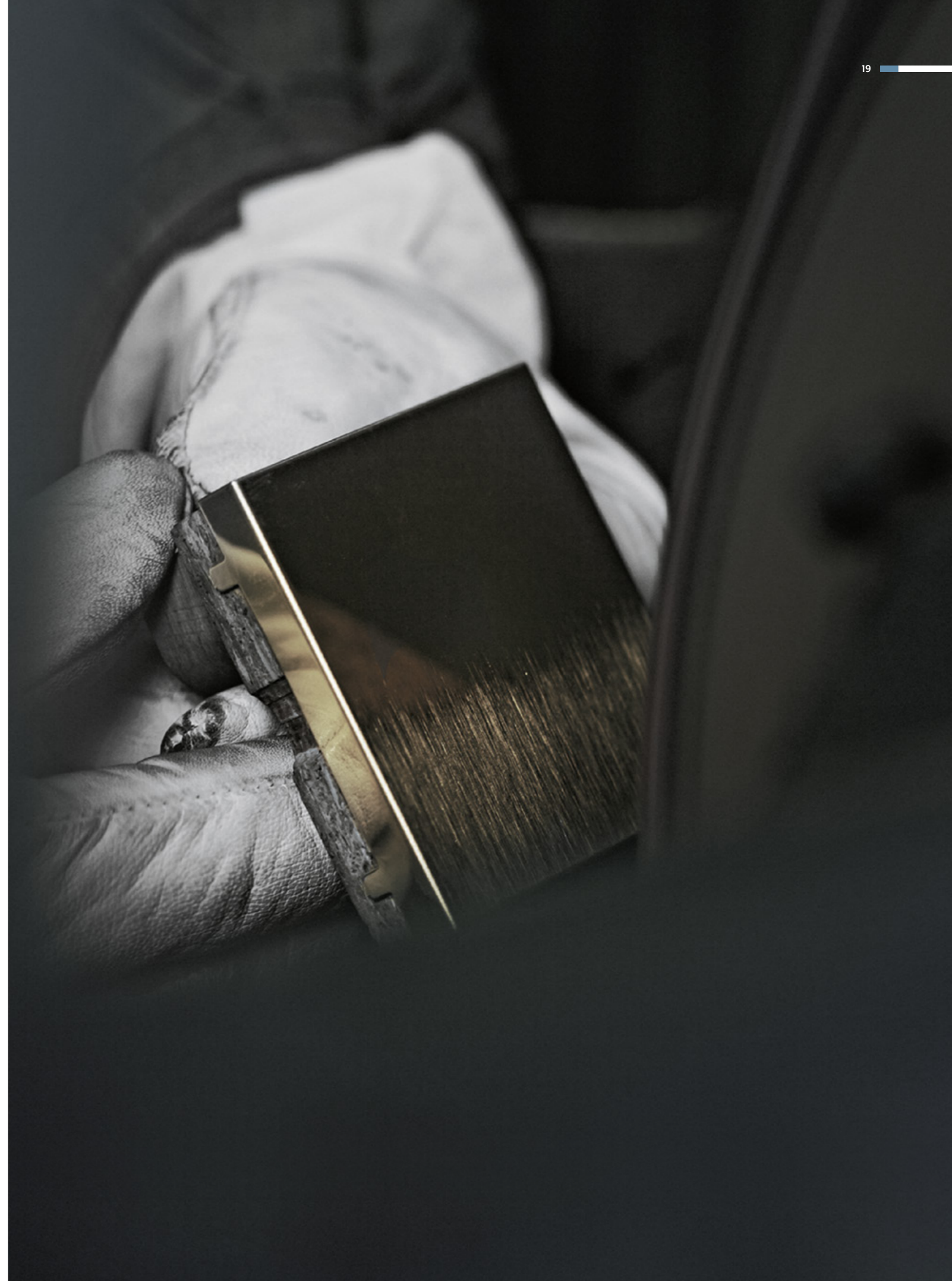

### Switch and control functions

Light, temperature, shutters or music – the functional diversity of A 550 perfectly covers all areas of modern electrical installation.

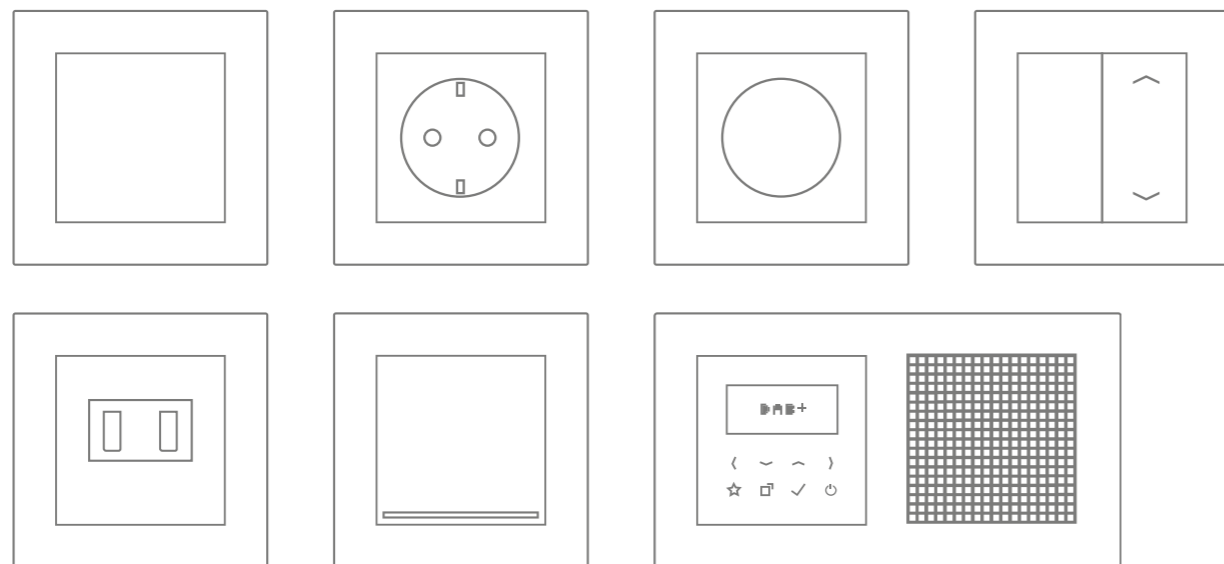

### Realise Smart Home with KNX

KNX networks functions such as lighting, climate, security and multimedia for central and intelligent control.

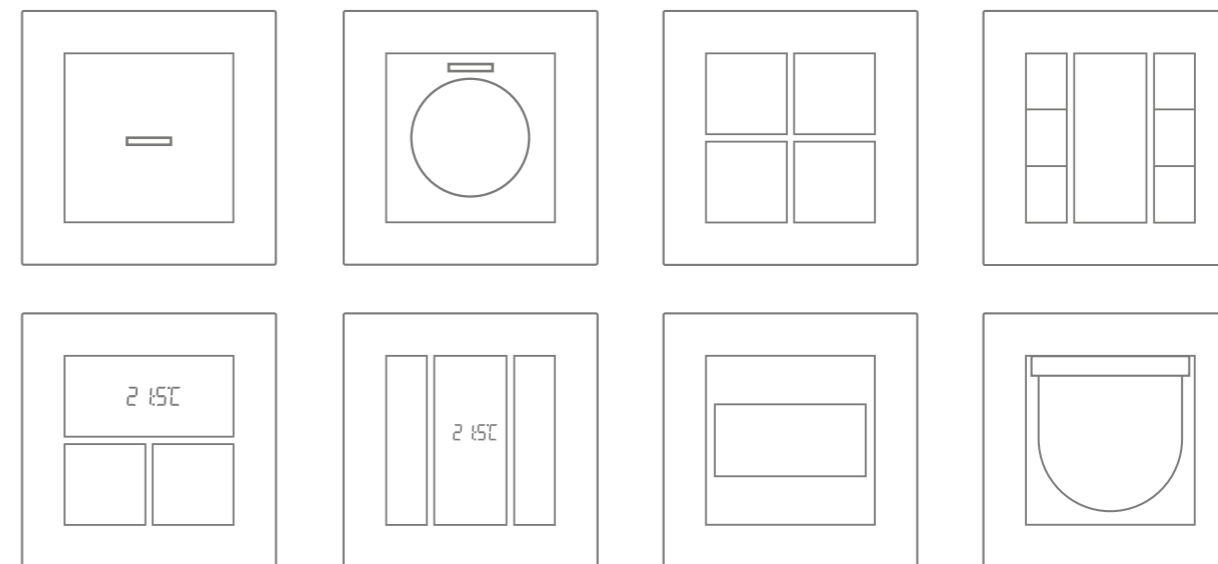

### LB Management

The modular system for modern lighting and shading control provides needs-based and easy-to-use solutions.

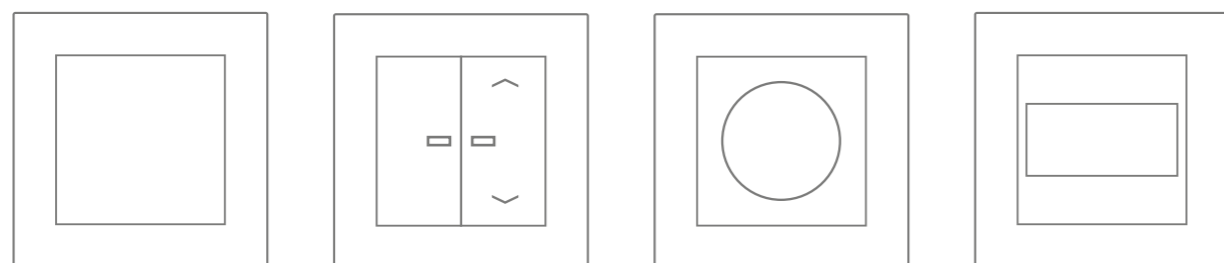

### Door intercom and house control

JUNG indoor stations stand for high functionality and easy operation. The JUNG modular system enables variable mounting of the individual modules.

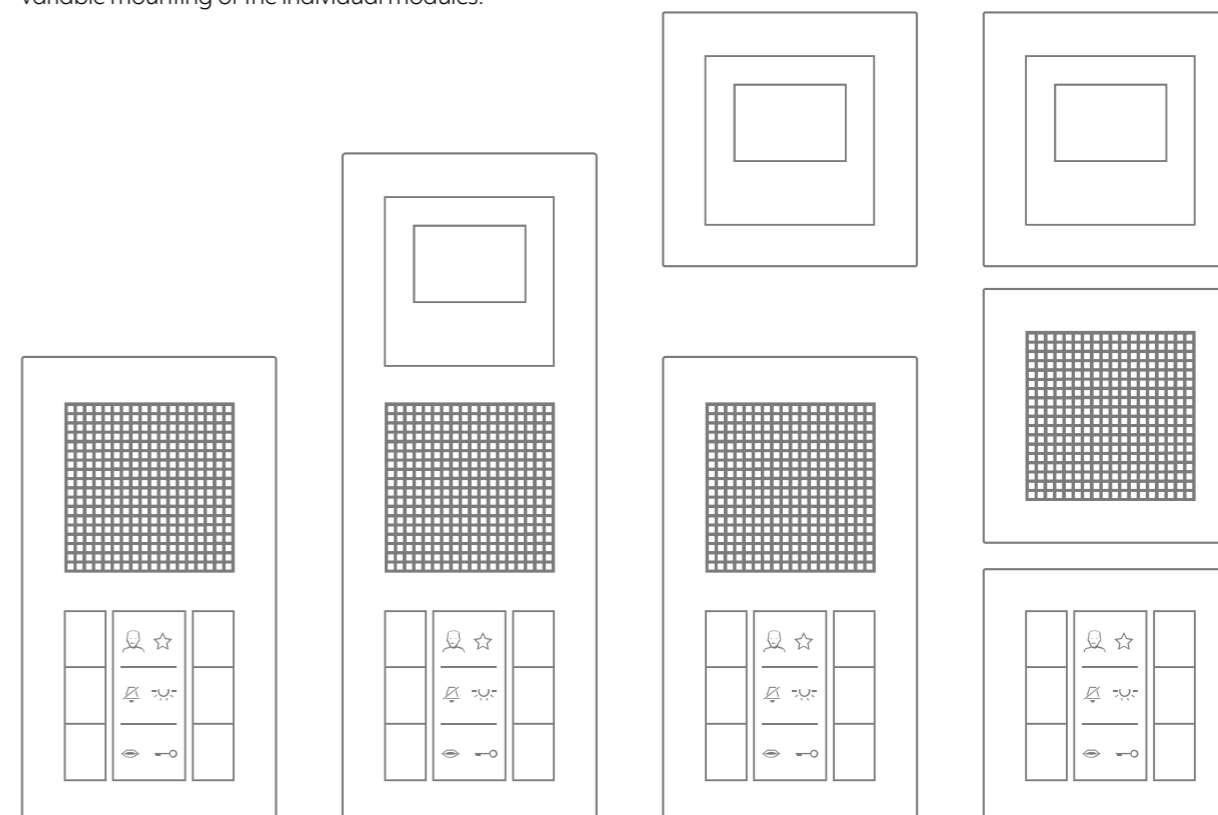

### eNet Smart Home

eNet is the wireless Smart Home system for the intelligent home. Functions are controlled via an app control panel or wall-mounted radio transmitter.

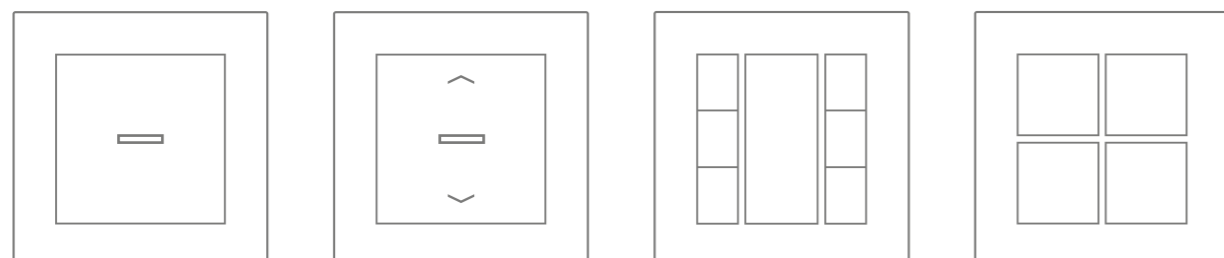



Puristic, elegant and sensual in perception: The switch range is available in six colours and can be mounted in 1- to 5-gang frames. A 550 provides numerous possible combinations.

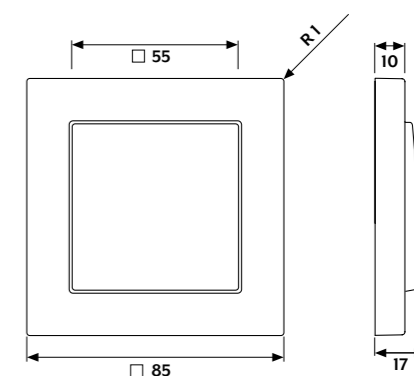
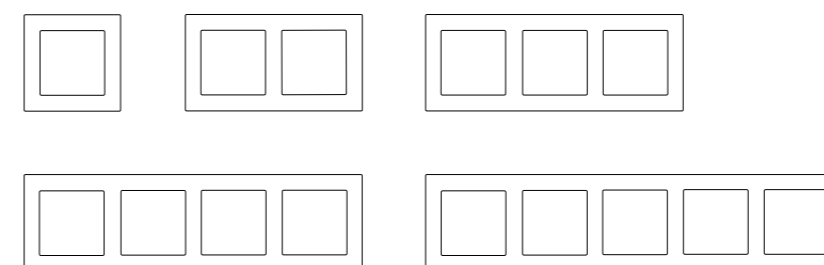
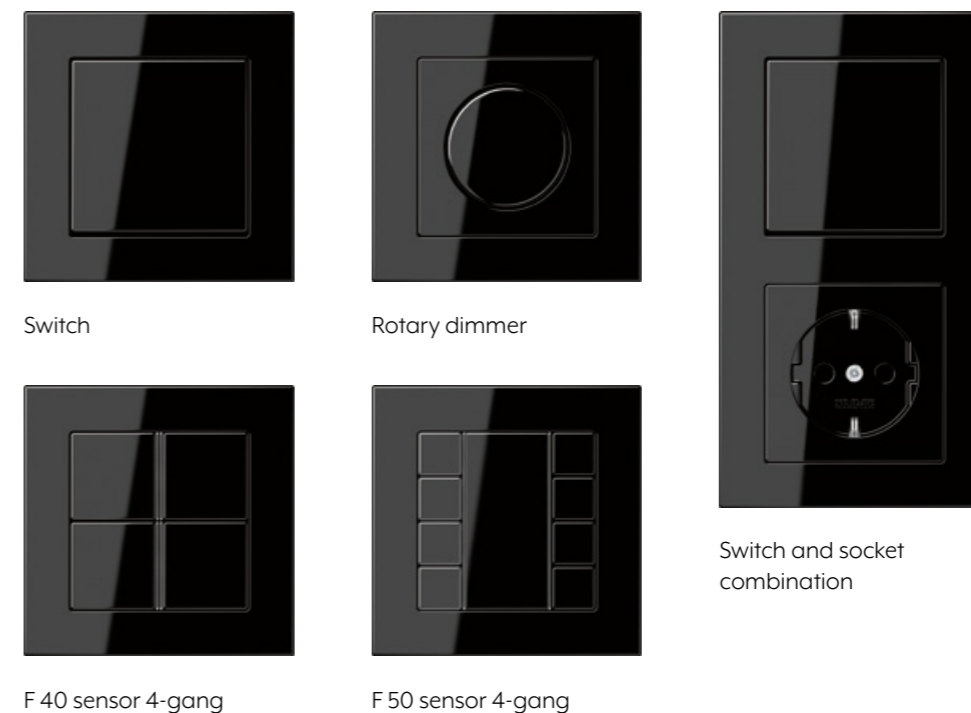

**Frame material**

Thermoplastic

Recommendation: Combine the frame with a cover made of thermoplastic (breakproof) high-gloss material.

**Colours**

- White
- Matt snow white
- Black
- Matt graphite black
- Aluminium
- Matt anthracite

**Frame dimensions**

1-gang	85 mm x 85 mm
2-gang	85 mm x 156 mm
3-gang	85 mm x 227 mm
4-gang	85 mm x 298 mm
5-gang	85 mm x 369 mm

The frames can be installed horizontally or vertically.

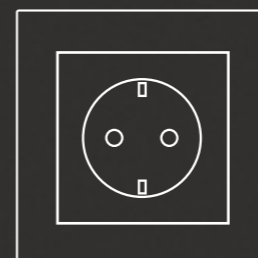

SCHUKO® Standard

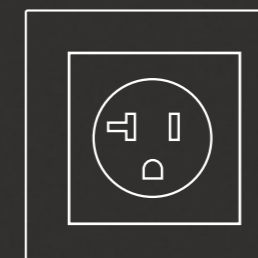

US NEMA Standard

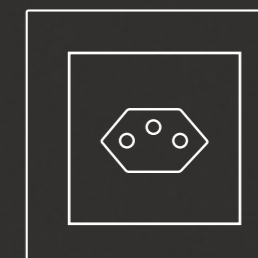

Swiss Standard, Type 13

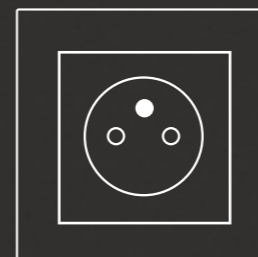
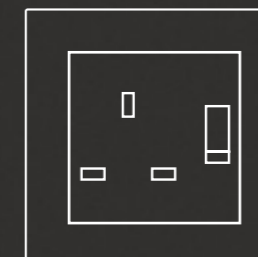
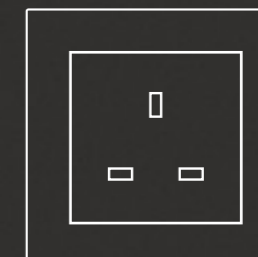
Socket with earth pin,  
French/BelgianBritish Standard 13 A,  
switchable

British Standard 13 A

## Stylish worldwide

Numerous international socket systems extend the A 550 range. They can be combined individually or in multiple frames according to the JUNG modular system.



Striking appearance: A 550 switch/  
push-button in black.



A 550 2-gang frame with 2-gang  
rocker and SCHUKO® socket.

With its elegant glass front in black or white, the Smart Radio DAB+ is a technical and optical highlight. It receives programmes via DAB+ and VHF and, in the Bluetooth version, via smartphone or tablet.

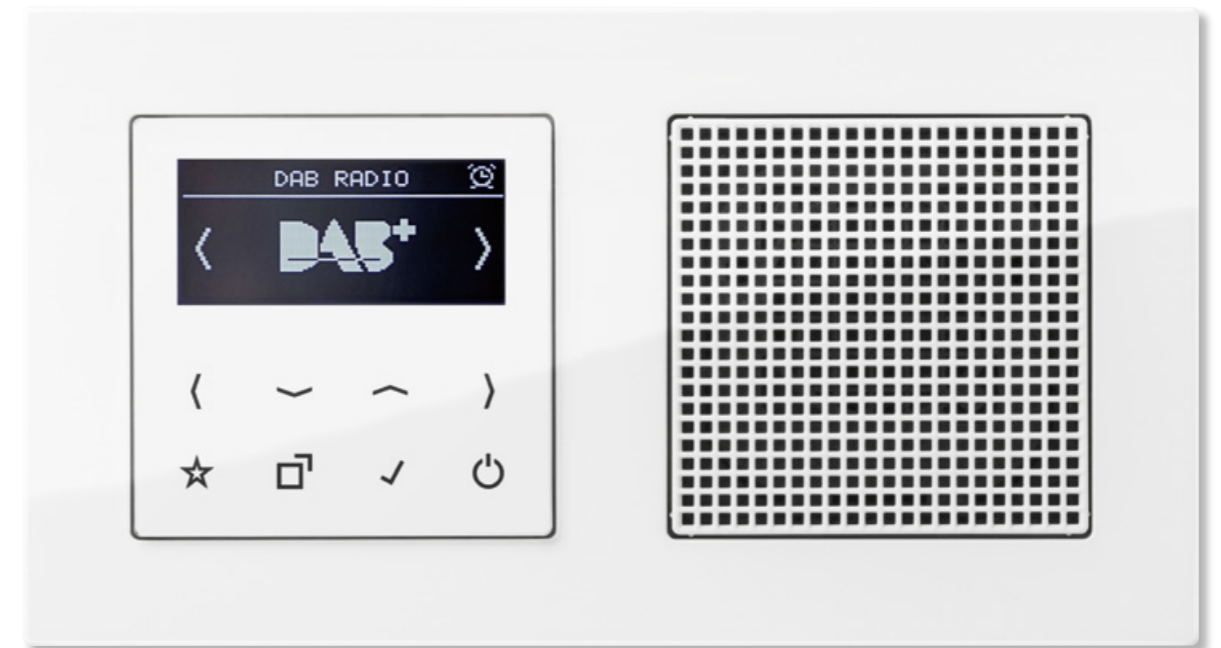

## Functional diversity with profile

From light, temperature, shutters or music to Smart Home solutions — A 550 combines many functions in a puristic design.

## Switches with character



white



matt graphite black

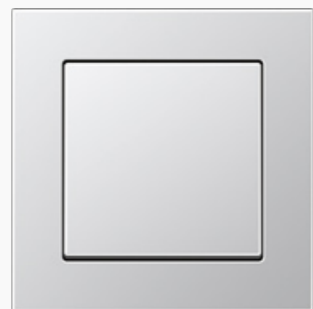

aluminium look



matt anthracite

Made of breakproof thermoplastic in optimal proportions:  
Whether in classic black or puristic matt snow white –  
A 550 sets accents in six elegant colour shades.



A 550 in black



A 550 in black







A 550 in matt snow white



## Reduced to the essentials

The striking, straight-line look of A 550 perfectly complements modern furnishing styles.



A 550 in black

## A 550

Stylish without compromises:  
A 550 convinces with its  
minimalist design and clear  
design language.



JUNG

A new generation

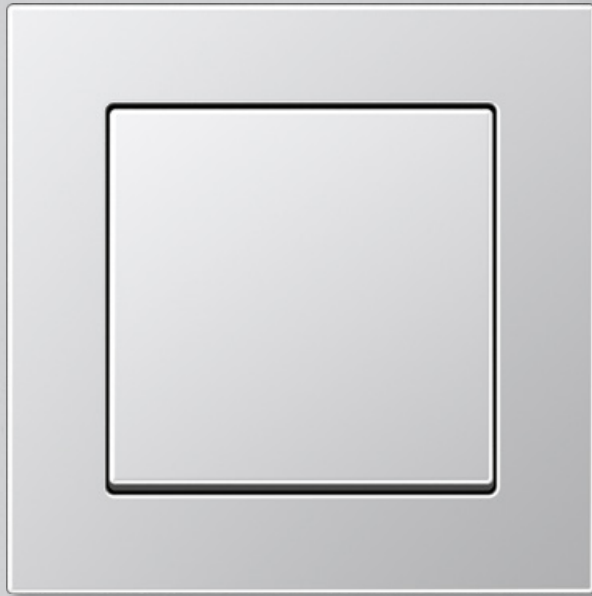

A 550

P-GB-FLOW550  
0322

MADE IN GERMANY SINCE 1912

JUNG-GROUP.COM